

HYX 45

DC

2040



HYX 45 - 2040 - DC

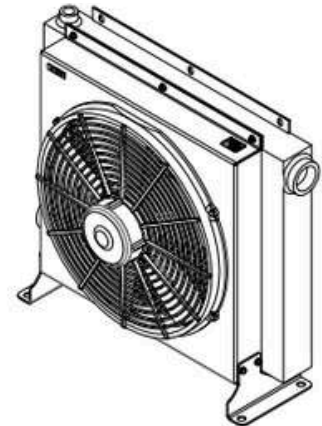
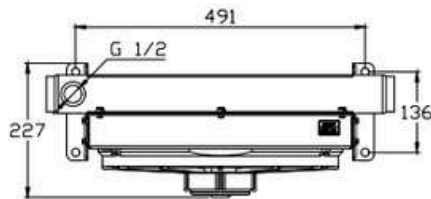
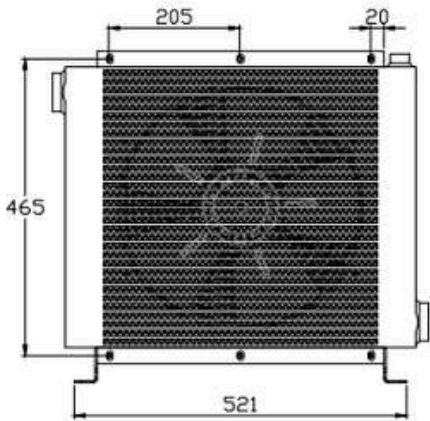
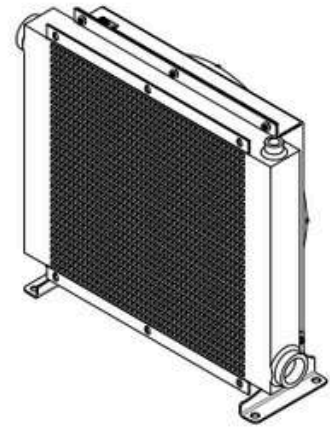
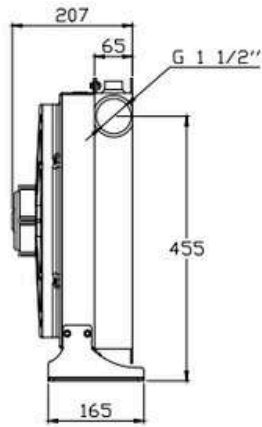
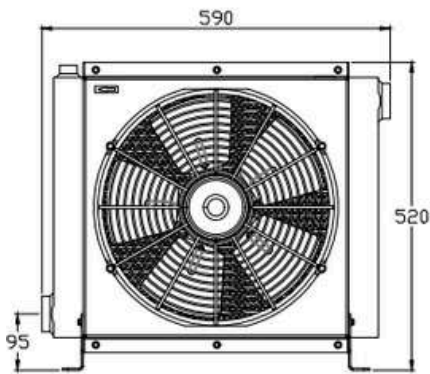

2040 PERFORMANCE DIAGRAM (KW/C°)

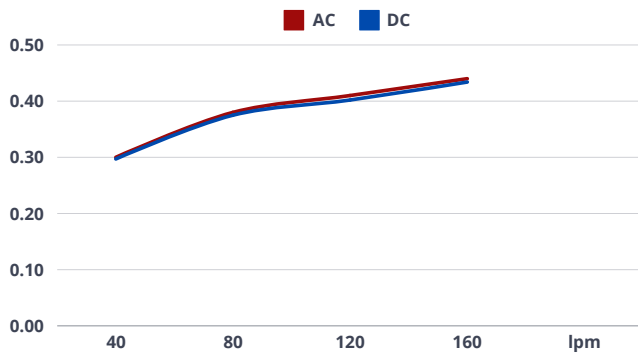

2040 PRESSURE DROP (BAR)

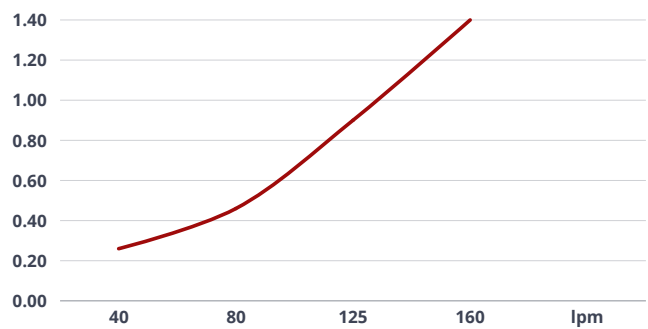

VOLTAGE	OIL FLOW MAX	MAX COOLING CAPACITY	REVOLUTIONS PER MINUTE	FAN Ø	NOISE LEVEL	AIR	WORKING PRESSURE	TEST PRESSURE
V	L/min	kcal/h	r/min	mm	dB	m³/h	bar	bar
12 24	160	20000	2900	385	-	2630	15	24